

# Pressure switch for gas DG

Technical Information · GB

4.1.1.4 Edition 01.11



- Simple switching point adjustment with infinitely adjustable hand wheel
- Monitoring of gas and air pressures (positive and negative pressures)
- Low pressure cut-off for gas and air (differential pressure)
- Pressure switch with internal lock and manual reset
- Suitable for biologically produced methane (can be used on pipes with Zone 2 explosive atmospheres without isolating amplifier)
- Can be used in Zone 1 and 2 hazardous areas with an approved isolating amplifier
- International approvals
- RoHS 2002/95/EC
- EC type-tested and certified pursuant to EN 1854 and class “S”
- TÜV test as a special-design pressure switch pursuant to TRD 604
- UL listed, FM and AGA approved
- Certified pursuant to GOST-R
- Certified for systems up to SIL 3 and PL e



krom  
schroder

## Content

Pressure switch for gas DG.....	1
Content.....	2
1 Application.....	3
1.1 Examples of application.....	4
1.1.1 Gas deficiency monitoring.....	4
1.1.2 Differential pressure monitoring.....	4
1.1.3 Closed position check.....	4
1.1.4 Negative pressure monitoring.....	4
1.1.5 Air line with minimum pressure and flow monitoring.....	5
1.1.6 Low-pressure cut-off and high gas pressure protection device.....	5
2 Certification.....	6
3 Function.....	7
3.1 Positive pressure measurement.....	7
3.2 Negative pressure measurement.....	7
3.3 Differential pressure measurement.....	7
3.4 Connection diagram.....	7
3.5 DG in Zone 1 and 2 hazardous areas.....	8
3.6 Animation.....	9
4 Selection.....	10
4.1 Selection table.....	10
4.2 Type code.....	10
5 Project planning information.....	11
5.1 Installation.....	11
5.2 Wiring.....	12
5.2.1 DG..B, DG..U, DG..H, DG..N.....	12
5.2.2 DG 18l, DG 120l, DG 450l.....	12
6 Accessories.....	13
6.1 Fastening set with screws, U-shape bracket.....	13
6.2 Connecting set.....	13
6.3 External adjustment.....	13
6.4 Pressure equalization element.....	13

Restrictor orifice.....	13
6.6 Test key PIA.....	14
6.7 Filter pad set.....	14
6.8 Tube set.....	14
6.9 Standard socket set.....	14
6.10 Pilot lamp set red or blue.....	14
6.11 LED set red/green.....	14
7 Technical data.....	15
7.1 Adjusting range, switching hysteresis.....	16
7.2 Safety-specific characteristic values for DG.....	17
7.2.1 Determining the PFH <sub>D</sub> value, the $\lambda_D$ value and the MTTF <sub>d</sub> value.....	18
7.2.2 Calculating the PFH <sub>D</sub> .....	18
7.3 Dimensions.....	21
8 Maintenance cycles.....	21
9 Glossary.....	22
9.1 Diagnostic coverage DC.....	22
9.2 Mode of operation.....	22
9.3 Category.....	22
9.4 Common cause failure CCF.....	22
9.5 Fraction of undetected common cause failures $\beta$ .....	22
9.6 B <sub>10d</sub> value.....	22
9.7 T <sub>10d</sub> value.....	22
9.8 Hardware fault tolerance HFT.....	22
9.9 Mean dangerous failure rate $\lambda_d$ .....	22
9.10 Safe failure fraction SFF.....	23
9.11 Probability of dangerous failure PFH <sub>D</sub> .....	23
9.12 Mean time to dangerous failure MTTF <sub>d</sub> .....	23
9.13 Demand rate n <sub>op</sub> .....	23
Feedback.....	24
Contact.....	24



## 1 Application



DG..U-3

Adjustable switching point



DG..H, DG..N

DG..H: switches and locks off with rising pressure. DG..N: switches and locks off with falling pressure. Manual reset.



DG..-6

With fitted socket pursuant to DIN EN 175301-803

The gas pressure switch DG monitors extremely low pressure differentials and triggers switch-on, switch-off or switch-over operations if a set switching point is reached. The switching point is adjustable between 0.4 and 500 mbar via a hand wheel.

It monitors gas pressures on various industrial gas and air appliances, such as boiler fan monitoring and differential pressure monitoring in firing, ventilation and air-conditioning systems.

The TÜV-tested special-design pressure switch is used as defined by VdTÜV Code of Practice "Druck 100/1" (Pressure 100/1) in firing installations for steam and hot-water generators in accordance with TRD 604, Para. 3.6.4, as well as class "S" for DG..B, DG..U and DG..I pursuant to EN 1854.

The pressure switch for gas DG can be used as positive pressure switch, vacuum sensor or differential pressure switch for air, flue gas and other non-aggressive gases. It is also suitable for biologically produced methane.

Type	Positive pressure	Negative pressure	Differential pressure
DG..B	Gas, air or flue gas	-	-
DG..U	Gas, air or flue gas	Air or flue gas	Air or flue gas
DG..H, DG..N	Gas, air or flue gas	Air or flue gas	Air or flue gas
DG..I	Air or flue gas	Gas, air or flue gas	Air or flue gas

## 1.1 Examples of application

### 1.1.1 Gas deficiency monitoring

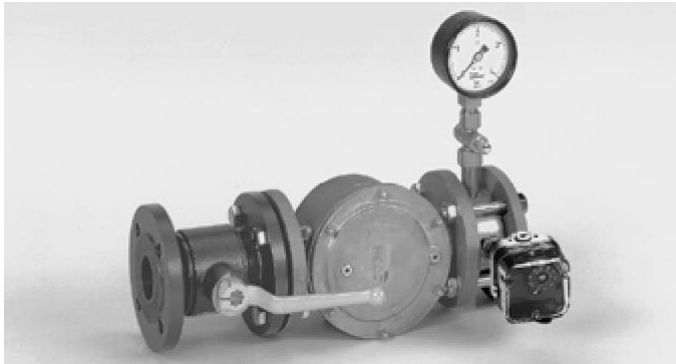

For monitoring the minimum gas inlet pressure

### 1.1.2 Differential pressure monitoring

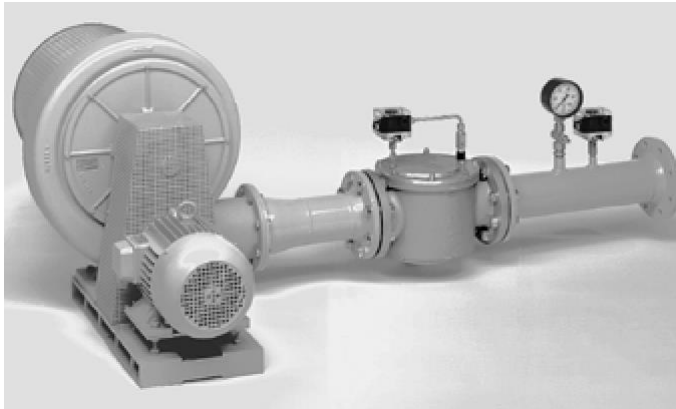

Differential pressure switch for monitoring air filters

### 1.1.3 Closed position check

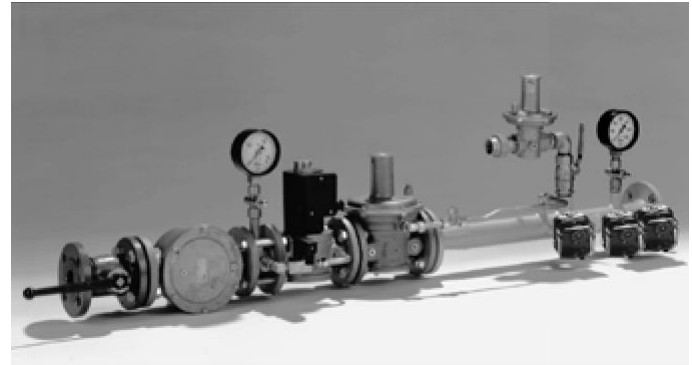

Electronic safety shut-off valve SAV with closed position check of downstream devices.

### 1.1.4 Negative pressure monitoring



Monitoring the negative pressure ensures the correct positioning of the components during fully automatic assembly of gas meters.

## 1.1.5 Air line with minimum pressure and flow monitoring

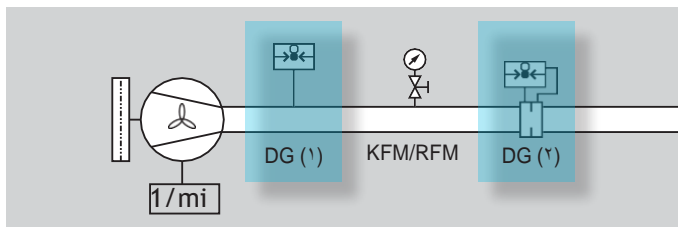

The air flow generated by the fan may be monitored as follows:

The static pressure is monitored by pressure switch DG (1), as long as it can be demonstrated that the display consequently shows an adequate and secured flow of air, or

DG (2) controls the flow of air via the differential pressure on the orifice.

If there is no air pressure supplied or if there is no differential pressure on the orifice, the system will be blocked.

## 1.1.6 Low-pressure cut-off and high gas pressure protection device

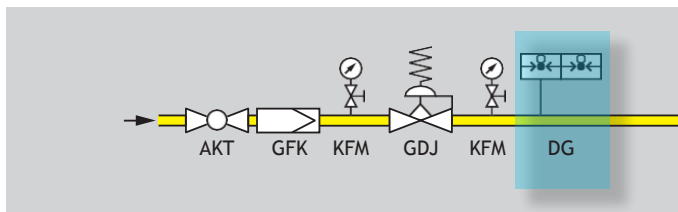

If the pressure is either too low or too high, the min./max. pressure switch DG switches in order to avoid start-up or to initiate a safety shut-down.

## 2 Certification

### SIL and PL certified



For systems up to SIL 3 pursuant to EN 61508 and PL e pursuant to ISO 13849

### EC type-tested and certified



pursuant to

- Gas Appliances Directive (2009/142/EC)

### Meets the requirements of the

- Low Voltage Directive (2006/95/EC)

### FM approval



Factory Mutual Research Class: 3510 Flow and pressure safety switches.

Designed for applications pursuant to NFPA 85 and NFPA 86.

[www.fmglobal.com](http://www.fmglobal.com) → Products and Services → Product Certification → Approval Guide

### UL approval



Standard: UL 353 Limit control.

Underwriters Laboratories - [www.ul.com](http://www.ul.com) → Certification

### AGA approval



Australian Gas Association, Approval No.: 5484

[http://www.aga.asn.au/product\\_directory](http://www.aga.asn.au/product_directory)

### Approval for Russia



Certified by Gosstandart pursuant to GOST-R.

Approved by Rostekhnadzor (RTN).

## 3 Function

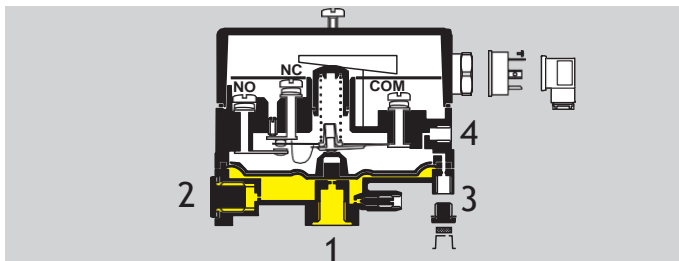

The pressure switch DG switches in the event of increasing or decreasing pressure. Once the set switching point is reached, a micro switch is activated in the DG which is designed as a change-over contact.

The switching pressure is adjusted using a hand wheel.

### 3.1 Positive pressure measurement

Positive pressure measurement is designed, for example, for checking the fan function or measuring the min. gas pressure.

The positive pressure is measured in the lower diaphragm chamber, port 1 or 2. The remaining ports are designed for ventilation.

In the case of DG..I, the positive pressure (gas, air, flue gas) is measured in the upper diaphragm chamber, port 3 or 4. The lower diaphragm chamber is ventilated via port 1 or 2.

### 3.2 Negative pressure measurement

Negative pressure measurement (air, flue gas) is designed, for example, for monitoring a suction pressure blower. The negative pressure is measured in the upper diaphragm chamber, port 3 or 4. The remaining ports are designed for ventilation.

In the case of DG..I, the negative pressure (gas, air, flue gas) is measured in the lower diaphragm chamber, port 1 or 2. The upper diaphragm chamber is ventilated via port 3 or 4.

### 3.3 Differential pressure measurement

Differential pressure measurement is designed for instance for safeguarding an air flow rate or for monitoring filters and fans.

DG..B, DG..U, DG..H, DG..N: The higher absolute pressure is connected to port 1 or 2, and the lower absolute pressure to port 3 or 4. The remaining ports must be tightly plugged.

### 3.4 Connection diagram

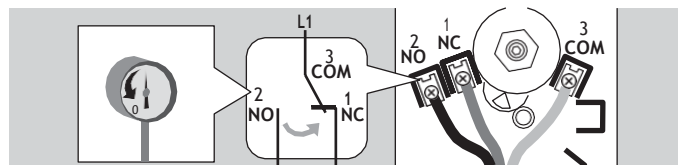

DG..B, DG..U und DG..H switch with rising pressure. The contact switches from NC 1 to NO 2.

DG..N switches with falling pressure. The contact switches from NO 2 to NC 1.

DG..H and DG..N are locked off in their switched state, and can only be unlocked with a manual reset.

### 3.5 DG in Zone 1 and 2 hazardous areas

Pressure switch DG can be used in Zone 1 and 2 hazardous areas if an isolating amplifier is installed upstream in the safe area as “Ex-i” equipment pursuant to EN 60079-11 (VDE 0170-7):2007.

DG as “simple electrical equipment” pursuant to EN 60079-11:2007 corresponds to the Temperature class T6, Group II. The internal inductance/capacitance is  $L_o = 0.2 \mu\text{H}/C_o = 8 \text{ pF}$ .

The isolating amplifier transfers the DG's signals from the explosion-hazard area to the safe area. Depending on the design of the intrinsically safe circuit, the explosion-hazard area can be monitored for cable faults, cable breaks or short-circuits.

Ensure that standard-compliant wiring pursuant to EN 60079 is used.

#### Intrinsically safe circuit without monitoring for cable faults

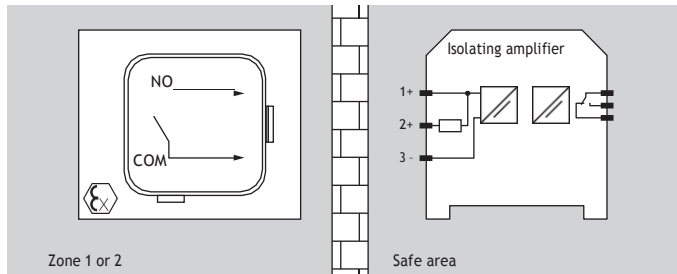

#### Intrinsically safe circuit with monitoring for cable breaks

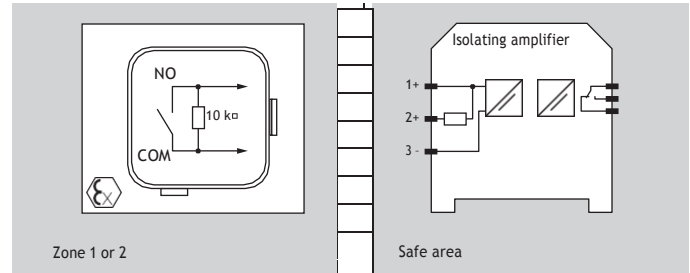

#### Intrinsically safe circuit with monitoring for cable faults and short-circuits

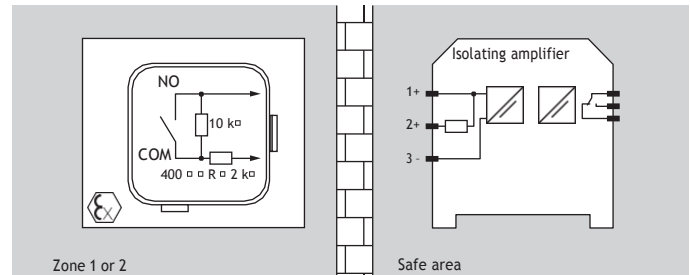



3.6 Animation

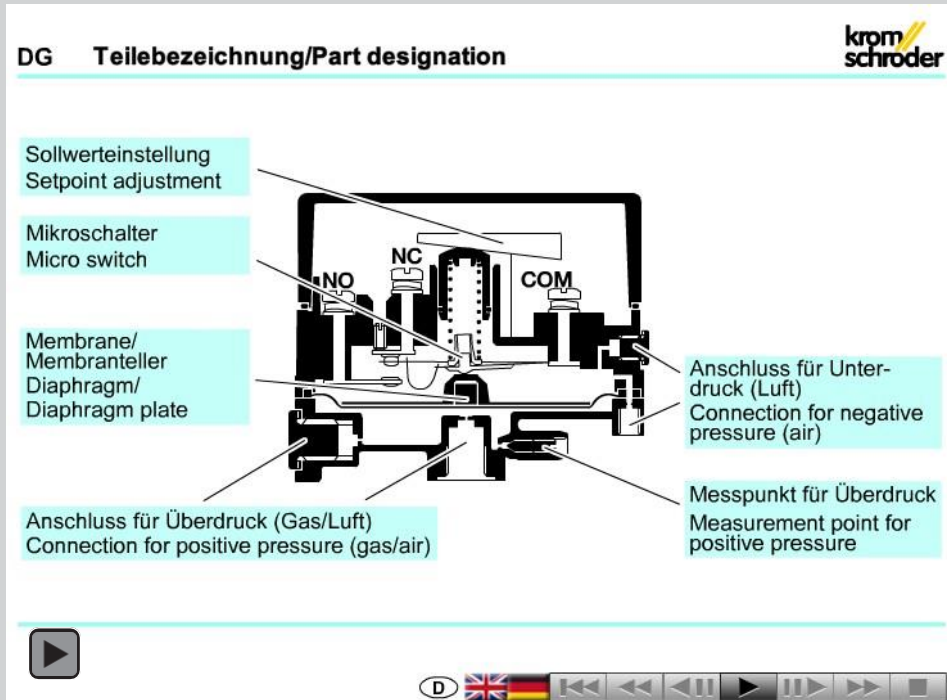

The interactive animation shows the function of the gas pressure switch DG.

Click on the picture. The animation can be controlled using the control bar at the bottom of the window (as on a DVD player). To play the animation, you will need Adobe Reader 7 or a newer version. If you do not have Adobe Reader on your system, you

can download it from the Internet. Go to [www.adobe.com](http://www.adobe.com), click on "Get Adobe Reader" and follow the instructions.

If the animation does not start to play, you can download it from the document library (Docuthek) as an independent application.

## 4 Selection

### 4.1 Selection table

Type	1.5	6	12	10	30	18	50	120	150	400	450	500	T	G	-3	-4	-5	-6	-9	K2	T	T2	N	S	A
DG..B, DG..U		•		•	•		•		•	•		•	•	•	•	•	•	•	•	•	•	•	•	•	•
DG..H, DG..N				•			•		•			•	•	•	•	•	•	•	•	•	•	•	•	•	•
DG..I	•		•			•		•			•		•	•	•	•	•	•	•	•	•	•	•	•	•

• = standard, O = available

#### Order example

DG 10UG-3K2

### 4.2 Type code

Code	Description
DG	Pressure switch for gas
1,5-500	Maximum setting in mbar
T	T-product
B	Positive pressure
U	Positive pressure, negative pressure, differential pressure
H	Locks off with rising pressure
N	Locks off with falling pressure
I	Negative pressure for gas
G	With gold-plated contacts
	Electrical connection:
-3	via screw terminals
-4	via screw terminals, IP 65
-5	via 4-pin plug, without socket
-6	via 4-pin plug, with socket
-9	via 4-pin plug, with socket, IP 65
K2	Red/green pilot LED for 24 V DC/AC
T	Blue pilot lamp for 230 V AC
T2	Red/green pilot LED for 230 V AC
N	Blue pilot lamp for 120 V AC
S	Only for oxygen and ammonia
A	External adjustment

## 5 Project planning information

### 5.1 Installation

Installation in the vertical or horizontal position, or sometimes upside down, preferably with vertical diaphragm.

If installed in a vertical position, the switching point  $p_s$  will correspond to the scale value SK set on the hand wheel. If installed in another position, the switching point  $p_s$  will change and no longer correspond to the scale value SK set on the hand wheel. Switching point  $p_s$  must be checked.

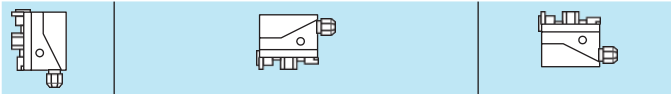

DG..U, DG..B, DG..H, DG..N

$p_s = SK$	$p_s = SK + 0.18 \text{ mbar}$	$p_s = SK - 0.18 \text{ mbar}$
------------	--------------------------------	--------------------------------

DG 18I, DG 120I, DG 450I

$p_s = SK$	DG 18I: $p_s = SK - 0.5 \text{ mbar}$ DG 120I, DG 450I: $p_s = SK - 0.2 \text{ mbar}$	
------------	--	--

DG 1,5I

$p_s = SK$	Negative pressure: $p_s = SK - 0.4 \text{ mbar}$ Positive pressure: $p_s = SK + 0.4 \text{ mbar}$	
------------	--	--

DG 12I

$p_s = SK$	Negative pressure: $p_s = SK - 0.5 \text{ mbar}$ Positive pressure: $p_s = SK + 0.5 \text{ mbar}$	
------------	--	--

The housing must not be in contact with masonry. Minimum clearance 20 mm.

The DG..B..S is suitable for oxygen and ammonia only. Ensure grease-free installation.

Continuous operation at high temperatures accelerates the ageing of elastomer materials. In places where a high thermal capacity is required, thermal equipment trips must be installed upstream of the pressure switch.

The service life will be shorter if subject to ozone concentrations exceeding  $200 \mu\text{g}/\text{m}^3$ . When installing outdoors, place the DG in a roofed area and protect from direct sunlight (even IP 65 version). To avoid condensation, the cover with pressure equalization element can be used, see page 13 (Pressure equalization element).

In case of highly fluctuating pressures, install a restrictor orifice, see page 13 (Restrictor orifice).

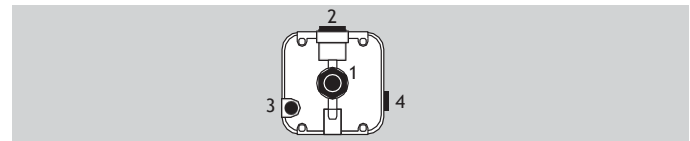

Ports 3 and 4 are connected to the upper diaphragm chamber. To prevent the micro switch from being damaged, no pipe conducting a gas/air mixture may be connected. Air and flue gas may not contain any aggressive constituents.

Use a filter pad at ports 3 and 4, in the event that the electrical contacts in the DG may be soiled by dirt particles in the surrounding air, see page 14 (Filter pad set).

Vapours containing silicone must not be allowed to get into the housing.

When using silicone tubes, only use silicone tubes which have been sufficiently cured.

Condensation must not be allowed to get into the housing. At subzero temperatures malfunctions or failures due to icing can occur.

## 5.2 Wiring

If the DG (DG..TG) has switched a voltage  $> 24\text{ V}$  ( $> 30\text{ V}$ ) and a current  $> 0.1\text{ A}$  at  $\varphi = 1$  or  $> 0.05\text{ A}$  at  $\varphi = 0.6$  once, the gold plating on the contacts will have been burnt through. It can then only be operated at this power rating or higher power rating.

In the case of low switching capacities, such as  $24\text{ V}$ ,  $8\text{ mA}$ , for example, we recommend using an RC module ( $22\ \Omega$ ,  $1\ \mu\text{F}$ ) in air containing silicone or oil.

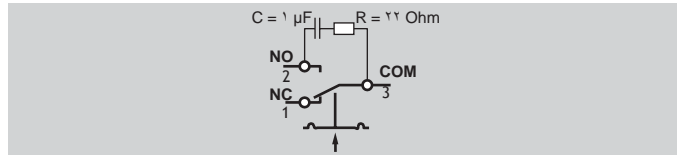

### 5.2.1 DG..B, DG..U, DG..H, DG..N

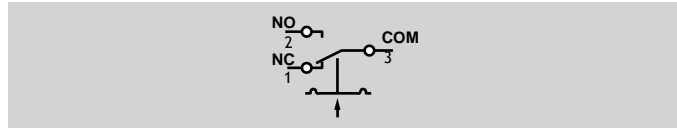

Contacts 3 and 2 close when subject to increasing pressure. Contacts 1 and 3 close when subject to falling pressure.

### 5.2.2 DG 18I, DG 120I, DG 450I

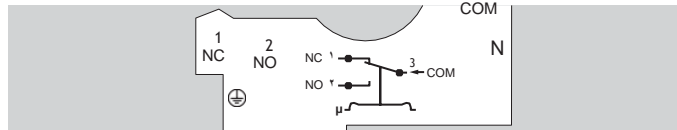

Contacts 3 and 2 close when subject to increasing negative pressure. Contacts 1 and 3 close when subject to falling negative pressure.

### DG 1,5I and DG 12I

The connection of DG 1,5I and DG 12I depends on the positive or negative adjusting range.

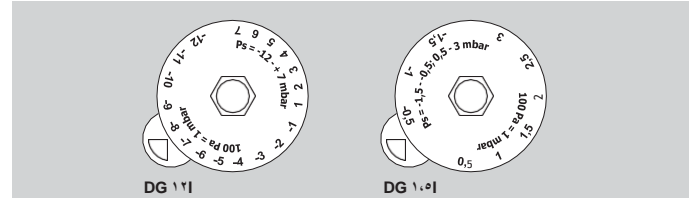

In the negative adjusting range, the template which can be found in the unit displays the connection diagram.

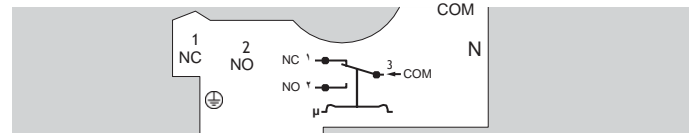

In the positive adjusting range, remove the template and wire the unit as shown in the engraved connection diagram.

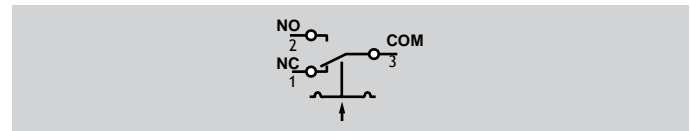

## 6 Accessories

### 6.1 Fastening set with screws, U-shape bracket

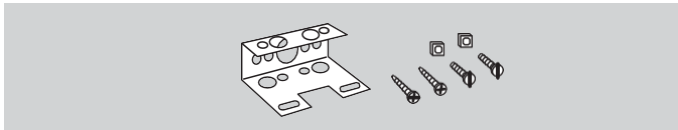

Order No.: 74915387

### 6.2 Connecting set



For monitoring a minimum and maximum inlet pressure  $p_e$  with two pressure switches DG..U attached to one another.

Order No.: 74912250

### 6.3 External adjustment

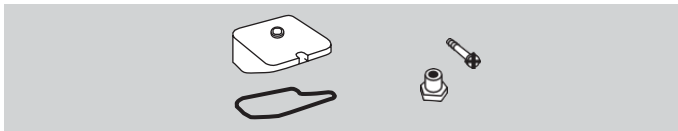

In order to set the switching pressure from the outside, the cover for external adjustment (6 mm Allen key) for DG..B, DG..U and DG..I can be retrofitted.

Order No.: 74916155

### 6.4 Pressure equalization element

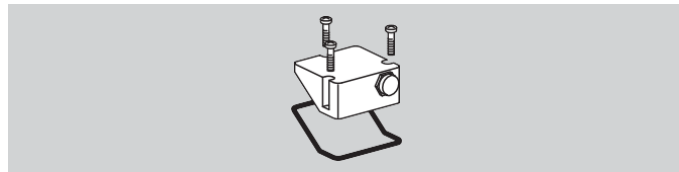

To avoid the formation of condensation, the cover with pressure equalization element can be used. The diaphragm in the screw connector is designed to ventilate the cover, without allowing water to enter.

Order No.: 74923391

### 6.5 Restrictor orifice

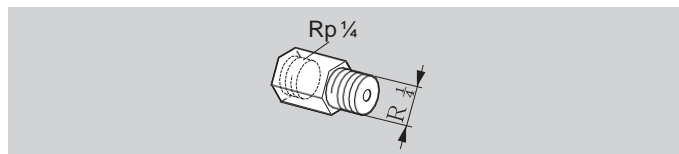

In the case of high pressure fluctuations, we recommend using a restrictor orifice (contains non-ferrous metals):

Hole diameter 2 mm, Order No.: 75456321,  
hole diameter 3 mm, Order No.: 75441317.

## 6.6 Test key PIA

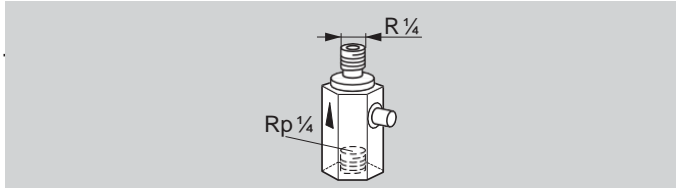

## 6.7 Filter pad set

To protect the electrical contacts in the DG from dirt particles in the surrounding air or in the medium, use a filter pad at the 1/8" negative pressure port. As standard on IP 65 units.

5-piece filter pad set, Order No.: 74916199

## 6.8 Tube set

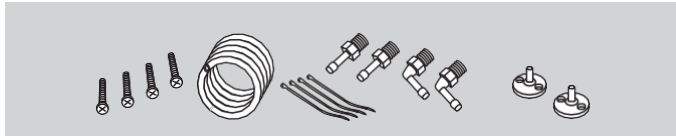

To be used with air only.

Order No.: 74912952.

## 6.9 Standard socket set

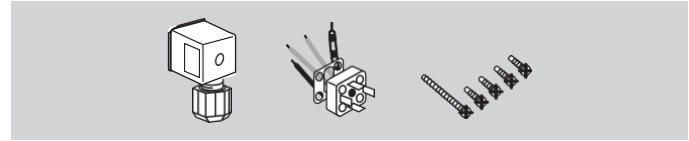

Order No.: 74915388.

## 6.10 Pilot lamp set red or blue

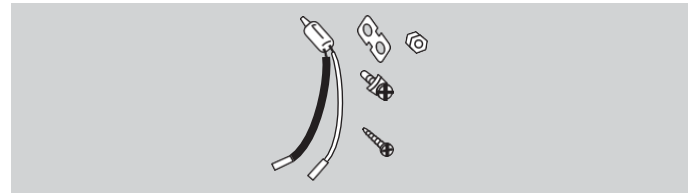

Pilot lamp red:

110/120 V AC, I = 1.2 mA, Order No.: 74920430;

220/250 V AC, I = 0.6 mA, Order No.: 74920429.

Pilot lamp blue:

110/120 V AC, I = 1.2 mA, Order No.: 74916121;

220/250 V AC, I = 0.6 mA, Order No.: 74916122.

## 6.11 LED set red/green

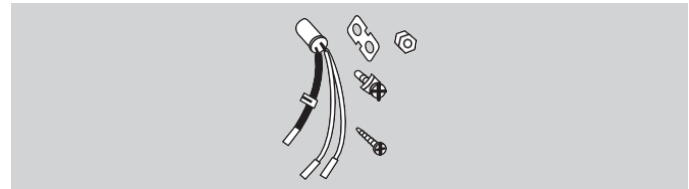

## 7 Technical data

Gas type: natural gas, town gas, LPG (gaseous), flue gas, biologically produced methane (max. 0.1 %-by-vol. H<sub>2</sub>S) and air.

DG..I: max. inlet pressure  $p_{e \text{ max.}} \pm 600 \text{ mbar}$  (8.5 psig).

Max. test pressure for testing the entire system: temporarily < 15 minutes 2 mbar (29 psig).

Switching capacity:

DG, 24 - 250 V AC:

$I = 0.05 - 5 \text{ A}$  at  $\cos \varphi = 1$ ,

$I = 0.05 - 1 \text{ A}$  at  $\cos \varphi = 0.6$ .

DG..G, 5 - 250 V AC:

$I = 0.01 - 5 \text{ A}$  at  $\cos \varphi = 1$ ,

$I = 0.01 - 1 \text{ A}$  at  $\cos \varphi = 0.6$ .

DG..G, 5 - 48 V DC:  $I = 0.01 - 1 \text{ A}$ .

DG..VCT, 30 - 240 V AC:

$I = 5 \text{ A}$  at  $\cos \varphi = 1$ ,

$I = 0.5 \text{ A}$  at  $\cos \varphi = 0.6$ .

DG..TG, < 30 V AC:

$I = 0.1 \text{ A}$  at  $\cos \varphi = 1$ ,

$I = 0.05 \text{ A}$  at  $\cos \varphi = 0.6$ .

If the DG (DG..TG) has switched a voltage > 24 V (> 30 V) and a current > 0.1 A at  $\varphi = 1$  or > 0.05 A at  $\varphi = 0.6$  once, the gold plating on the contacts will have been burnt through. It can then only be operated at this power rating or higher power rating.

Maximum medium temperature:

DG..B, DG..U, DG..I: -15 to +80°C (5 to 176°F),

DG..H, DG..N: -15 to +60°C (5 to 140°F).

Storage and transport temperature:

-40 to +80°C (-40 to 176°F).

RoHS compliant pursuant to 2002/95/EC.

Diaphragm pressure switch, silicone-free.

Diaphragm: NBR.

Housing: glass fibre reinforced PBT plastic with low gas release.

Lower housing section: AlSi 12.

Enclosure:

IP 54 or IP 65.

Safety class: 1.

Line entrance: M16 x 1.5, clamping range: diameters of 4 to 10 mm.

Type of connection: screw terminals.

Weight: 320 g (11.3 oz).

## 7.1 Adjusting range, switching hysteresis

On DG..B, DG..U, DG..H and DG..I, the scale value is set to the switch-on point, and on DG..N, it is set to the switch-off point.

Type	Adjusting range*		Mean switching differential at min. and max. setting		Difference between switching pressure and possible reset		Deviation from the switching point during testing pursuant to EN 1854	
	mbar	"WC	mbar	"WC	mbar	"WC	Gas pressure switch	Air pressure switch
DG 6B, DG 6U	0.4 - 6	0.16 - 2.34	0.2 - 0.3	0.08 - 0.12	-	-	± 15%	± 15% or 0.1 mbar (0.04 "WC)
DG 10B, DG 10U	1 - 10	0.39 - 3.9	0.25 - 0.4	0.1 - 0.16	-	-	± 15%	± 15%
DG 30B, DG 30U	2.5 - 30	1 - 11.7	0.35 - 0.9	0.14 - 0.35	-	-	± 15%	± 15%
DG 50B, DG 50U	2.5 - 50	1 - 19.5	0.8 - 1.5	0.31 - 0.59	-	-	± 15%	± 15%
DG 150B, DG 150U	30 - 150	11.7 - 58.5	3 - 5	1.17 - 1.95	-	-	± 15%	± 15%
DG 400B, DG 400U	50 - 400	19.5 - 156	5 - 15	1.95 - 5.85	-	-	± 15%	± 15%
DG 500B, DG 500U	100 - 500	39 - 195	8 - 17	3.12 - 6.63	-	-	± 15%	± 15%
DG 10H, DG 10N	1 - 10	0.39 - 3.9	-	-	0.4 - 1	0.16 - 0.39	± 15%	± 15%
DG 50H, DG 50N	2.5 - 50	1 - 19.5	-	-	1 - 2	0.39 - 0.78	± 15%	± 15%
DG 150H, DG 150N	30 - 150	11.7 - 58.5	-	-	2 - 5	0.78 - 1.95	± 15%	± 15%
DG 500H, DG 500N	100 - 500	39 - 195	-	-	4 - 17	1.56 - 6.63	± 15%	± 15%

\* Adjusting tolerance = ± 15% of the scale value.

Type	Adjusting range* [mbar]	Mean switching differential at min. and max. setting [mbar]	Deviation from the switching point during testing pursuant to EN 1854	
			Gas pressure switch	Air pressure switch
DG 1,5I	-1.5 to -0.5 and +0.5 to +3	0.2 - 0.5	± 15%	± 15% or 0.4 mbar
DG 12I	-12 to -1 and +1 to +7	0.5 - 1	± 15%	± 15% or 0.5 mbar
DG 18I	-2 to -18	0.5 - 1.5	± 15%	± 15% or 0.5 mbar
DG 120I	-10 to -120	4 - 11	± 15%	± 15%
DG 450I	-80 to -450	10 - 30	± 15%	± 15%



## 7.2 Safety-specific characteristic values for DG

<b>For SIL</b>	
Suitable for Safety Integrity Level	SIL 1, 2, 3
Diagnostic coverage DC	0
Type of subsystem	Type A to EN 61508-2, 7.4.3.1.2
Mode of operation	High demand mode pursuant to EN 61508-4:2001, 3.5.12
<b>For PL</b>	
Suitable for Performance Level	PL a, b, c, d, e
Category	B, 1, 2, 3, 4
Common cause failure CCF	> 65
Application of essential safety requirements	Satisfied
Application of tried-and-tested safety requirements	Satisfied
<b>For SIL and PL</b>	
	$B_{10d}$ value
U = 24 V DC, I = 10 mA; U = 230 V AC, I = 4 mA	6,689,477 operating cycles
U = 24 V DC, I = 70 mA; U = 230 V AC, I = 20 mA	3,887,652 operating cycles
U = 230 V AC, I = 2 A	974,800 operating cycles
Hardware fault tolerance (1 component/switch) HFT	0

Hardware fault tolerance (2 components/switches, redundant operation) HFT	1
Safe failure fraction SFF	> 90%
Fraction of undetected common cause failures $\beta$	$\geq 2\%$

Max. service life under operating conditions:  
10 years after date of production, plus max. 1/2 year in storage prior to first use, or once the given number of operating cycles has been reached, depending on which is achieved first.

For a glossary of terms, see page 22 (Glossary).

Max. switching capacity: U = 24 V DC, I = 10 mA; U = 230 V AC, I = 4 mA, 6,689,477 operating cycles

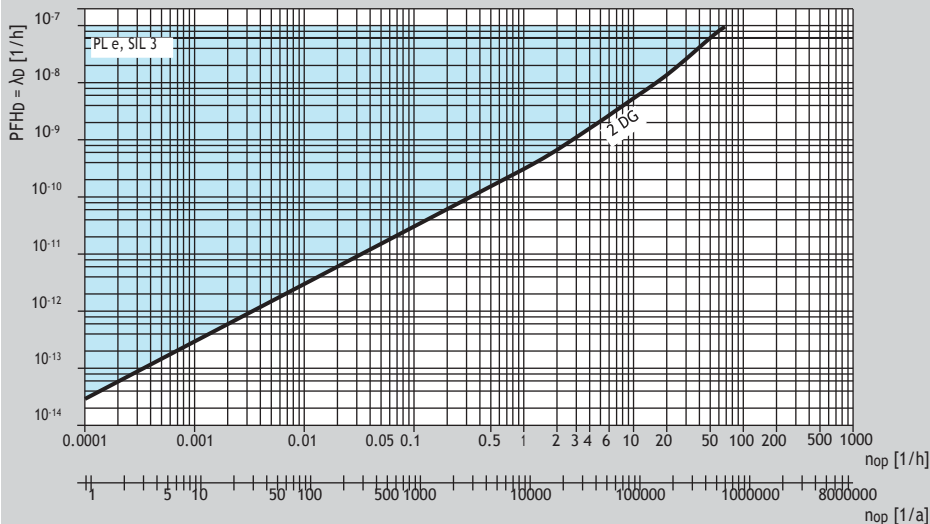
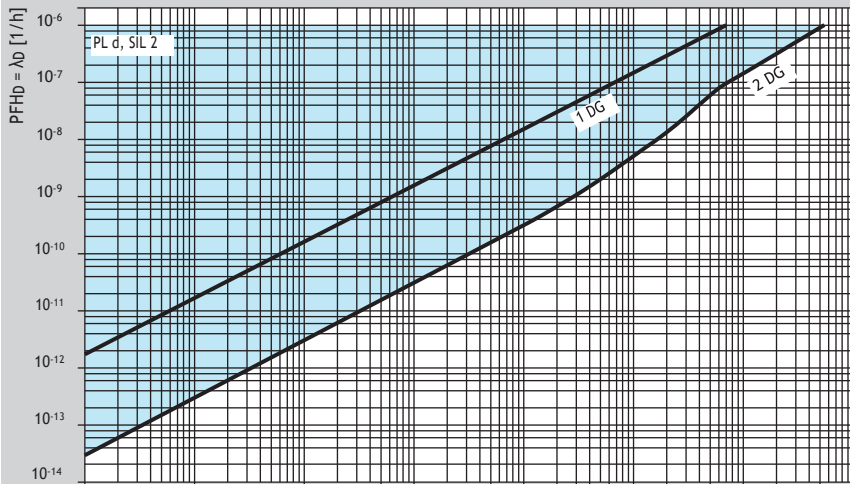

### 7.2.1 Determining the PFH<sub>D</sub> value, the λ<sub>D</sub> value and the MTTF<sub>d</sub> value

$$PFH_D = \lambda_D = \frac{1}{MTTF_d} = \frac{0,1}{B_{10d}} \times n_{op}$$

PFH<sub>D</sub> = Probability of dangerous failure [1/hour]

λ<sub>D</sub> = Mean dangerous failure rate [1/hour]

MTTF<sub>d</sub> = Mean time to dangerous failure [hours]

n<sub>op</sub> = Demand rate (mean number of annual operations) [1/hour]

### 7.2.2 Calculating the PFH<sub>D</sub>

switch. cap.		1/h
n <sub>op</sub>		1/a
Cycle time		s
B <sub>10d</sub>		a
T <sub>10d</sub>		a
PFH <sub>D</sub> (1 DG)		1/h
suitable for		
PFH <sub>D</sub> (2 DG)		1/h
suitable for		

Max. switching capacity: U = 24 V DC, I = 70 mA; U = 230 V AC, I = 20 mA, 3,887,652 operating cycles

Determining the PFH<sub>D</sub> value, see page 18 (Calculating the PFHD).

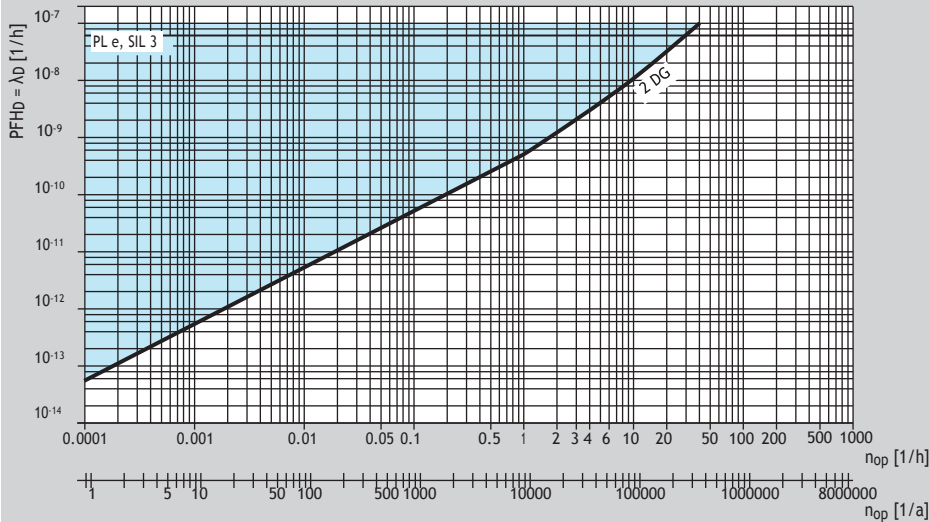
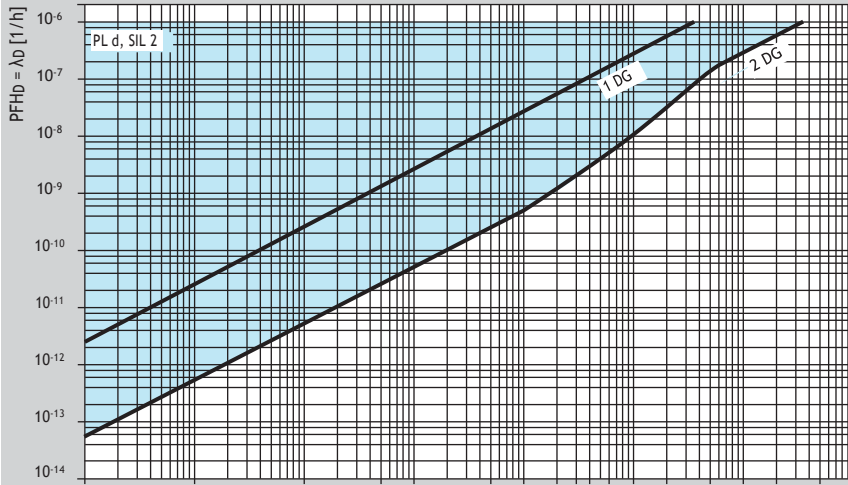

Max. switching capacity:  $U = 230 \text{ V AC}$ ,  $I = 2 \text{ mA}$ , 974,800 operating cycles

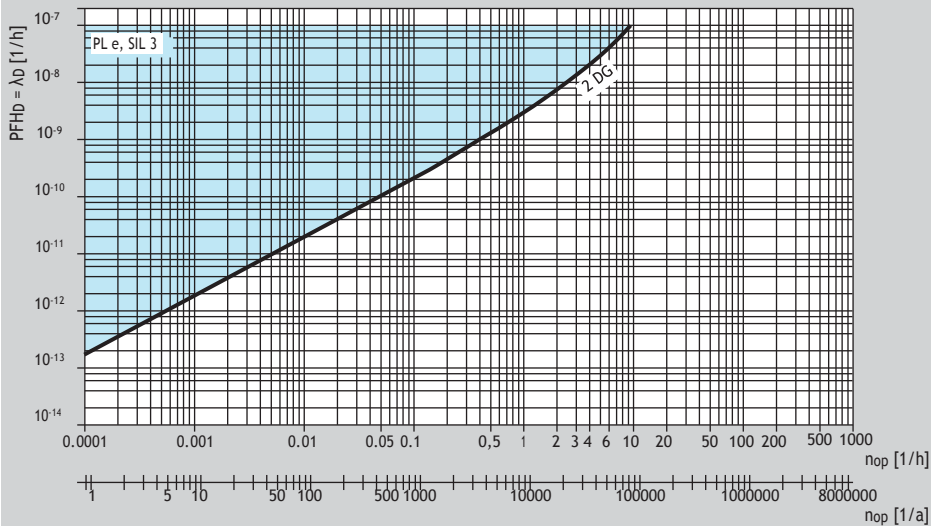
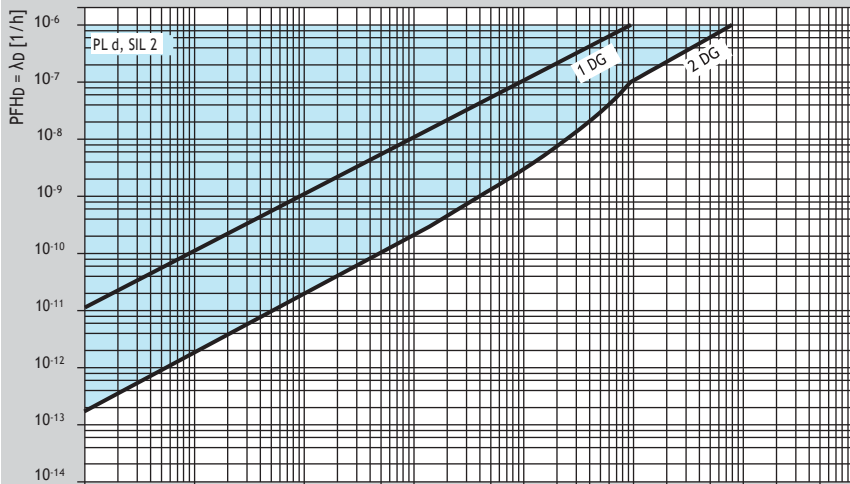

Determining the PFH<sub>D</sub> value, see page 18 (Calculating the PFHD)

## 7.3 Dimensions

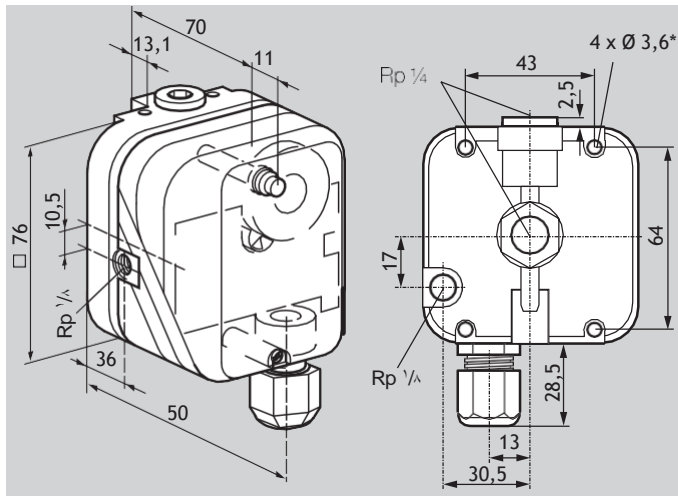

\* Holes 10 mm deep, for self-tapping screws.

## 9 Glossary

### 9.1 Diagnostic coverage DC

Measure of the effectiveness of diagnostics, which may be determined as the ratio between the failure rate of detected dangerous failures and the failure rate of total dangerous failures

NOTE: Diagnostic coverage can exist for the whole or parts of a safety-related system. For example, diagnostic coverage could exist for sensors and/or logic system and/or final

elements. Unit: %.

from EN ISO 13849-1:2008

### 9.2 Mode of operation

High demand mode or continuous mode

Operating mode, where the frequency of demands for operation made on a safety-related system is greater than one per year or greater than twice the proof-test frequency

from EN 61508-4:2001

### 9.3 Category

Classification of the safety-related parts of a control system in respect of their resistance to faults and their

## 8 Maintenance cycles

At least once a year, twice a year in the case of biologically produced methane.

subsequent behaviour in the fault condition, and which is achieved by the structural arrangement of the parts, fault detection and/ or by their reliability

from EN ISO 13849-1:2008